

DESCRIPTION AND MATERIAL	<ul style="list-style-type: none">• Molded neoprene with improved sealing ability.• Two to eight contacts.• Up to 300 VDC, 7 AMPS.• Rated to 10,000 psi, contact factory for higher rating.• Bulkhead connector design open face pressure rated to 5000 PSI.• O-rings molded in female connector.
CABLE	<ul style="list-style-type: none">• Connectors in this series are molded on a 24" length of 18 AWG SO cable (2 contact on SJO) unless otherwise specified.• Bulkhead connectors have 12" teflon leads, Type E per MIL 16878/4 18 AWG, or 12" Belden 34918 leads (Neoprene jacket).
USES	<ul style="list-style-type: none">• Mates with other manufacturers connectors of same design.• Permits underwater plugging and unplugging with power off.• Light to heavy duty applications.• Hazardous environments.
GUIDELINES	<ul style="list-style-type: none">• All mounting surfaces require a 32 finish.• Lubricate male pins liberally with Dow Corning #111 Valve Lubricant or equivalent and apply a small amount in each hole of female socket. Connectors must be lubricated on a regular basis.• Lubricate o-rings with Dow Corning #111 Valve Lubricant or equivalent.• Replace o-rings when re-using connectors.• Align index pin prior to mating.• Avoid nicks and cuts around contacts as these are the sealing surfaces.• Elastomers can be seriously degraded if exposed to direct sunlight or high ozone levels for extended periods of time.• Do not over tighten bulkhead nuts.• Do not pull on cable to disconnect.• Avoid sharp bends at cable entry to connector.

IE2-BC

IE UNDERWATER PLUGGABLE SERIES

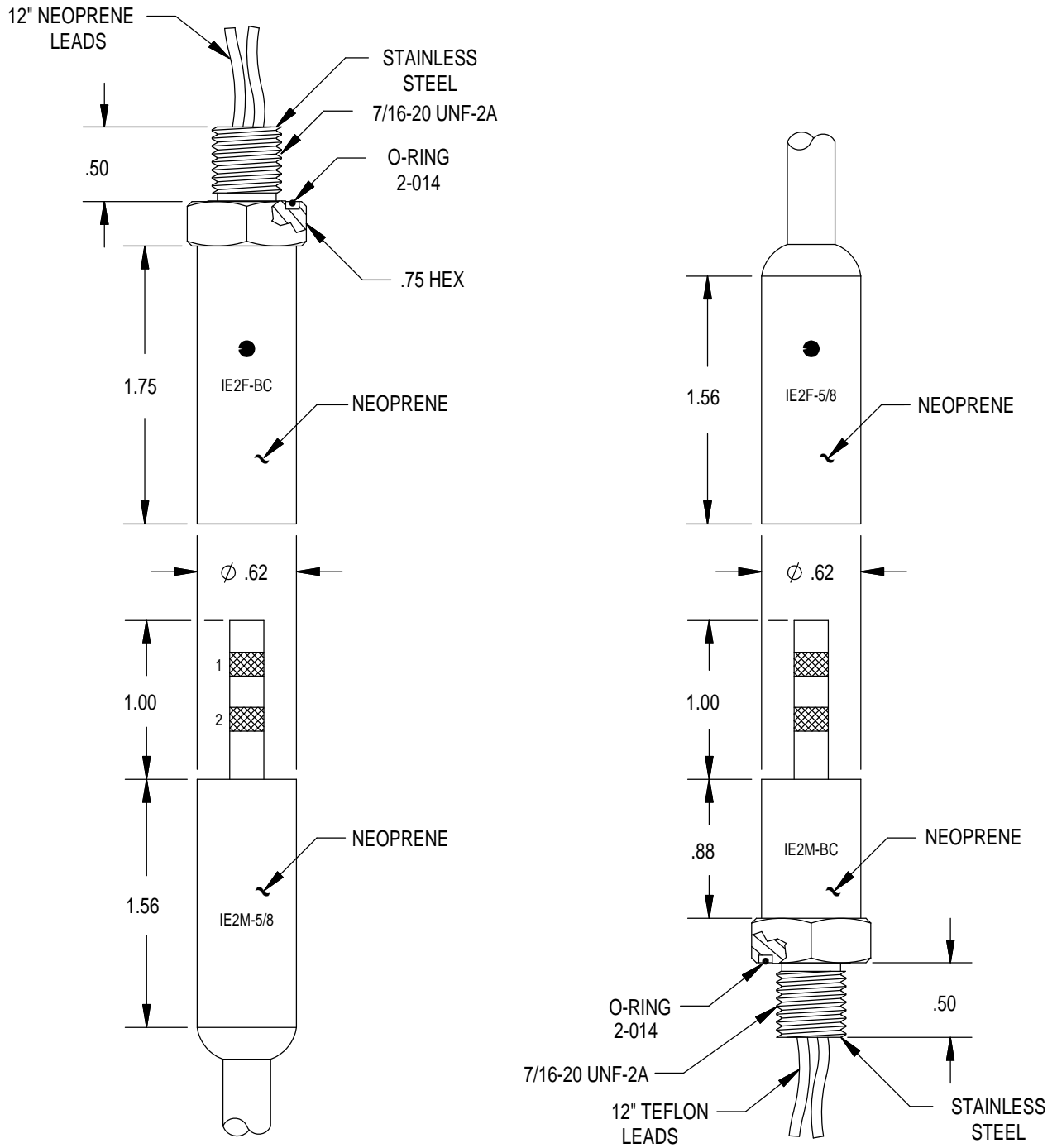

MOUNTING TORQUE FOR BC	not to exceed 100 in lbs
MATED PRESSURE RATING (psi)	10,000
DUMMY PLUG FOR IE2M-5/8, IE2M-BC	IE2F-5/8-DO *
DUMMY PLUG FOR IE2F-BC, IE2F-5/8	IE2M-5/8-DO *
* Dummy plugs found on Page 75 62.	
* Shorted dummies (DS) available upon request.	

IERD2-BC

IE UNDERWATER
PLUGGABLE SERIES

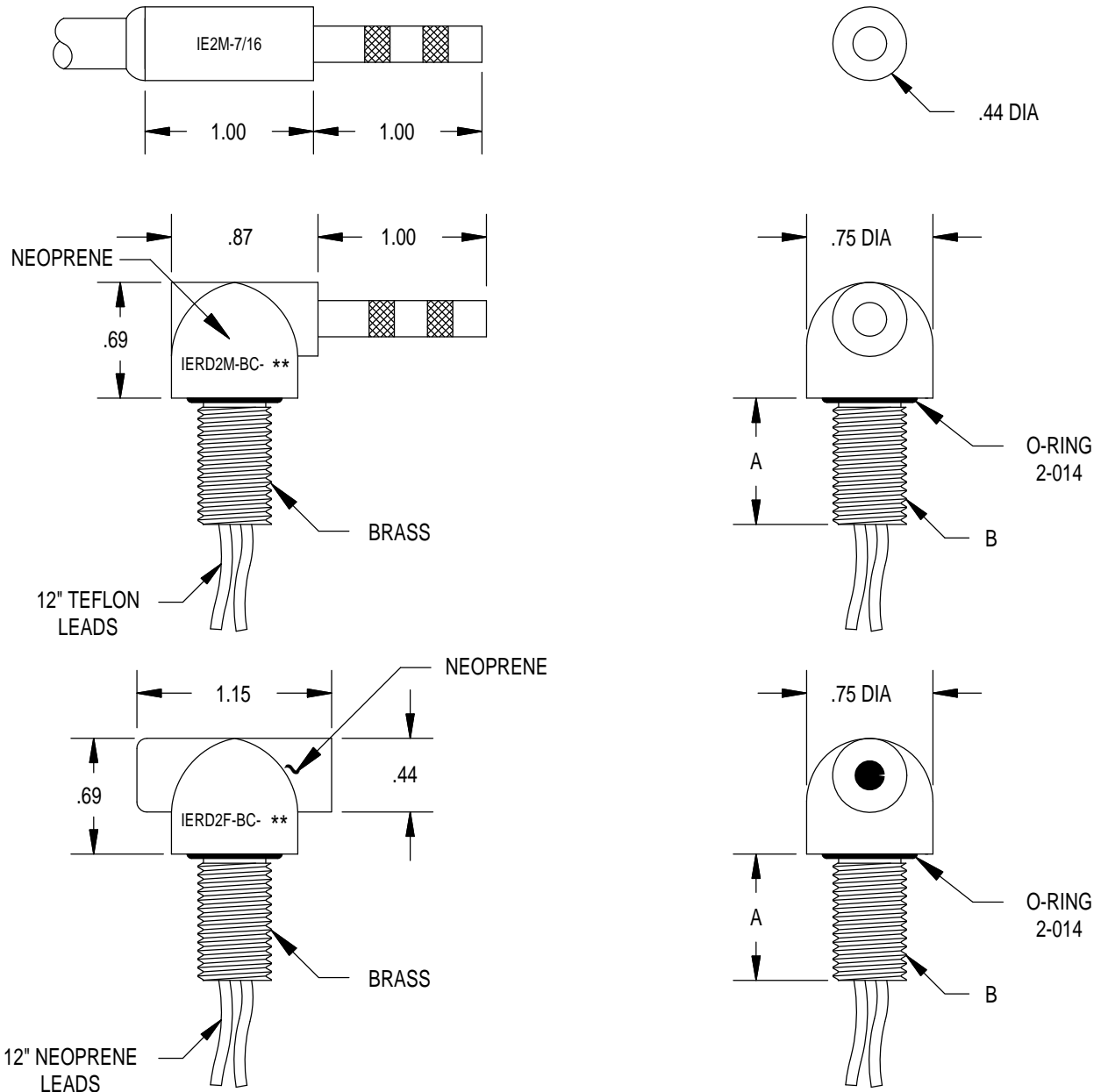

MOUNTING TORQUE FOR BC	not to exceed 100 in lbs
MATED PRESSURE RATING (psi)	10,000
DUMMY PLUG FOR IERD2F-BC	IE2M-7/16-DO *
DUMMY PLUG FOR IERD2M-BC	IE2F-5/8 DO *
<p>* Dummy plugs found on Page 75 62. ** Shorted dummies (DS) available upon request. *** See chart for thread specifications. **** Specify M/F</p>	

PART NUMBER	B	A
IERD2****-BC-1	3/8-24 UNF-2A	.50
IERD2****-BC-2	3/8-24 UNF-2A	.75
IERD2****-BC-3	3/8-24 UNF-2A	1.00
IERD2****-BC-4	7/16-20 UNF-2A	.50
IERD2****-BC-5	7/16-20 UNF-2A	.75
IERD2****-BC-6	7/16-20 UNF-2A	1.00

IESQ4-BC

IE UNDERWATER
PLUGGABLE SERIES

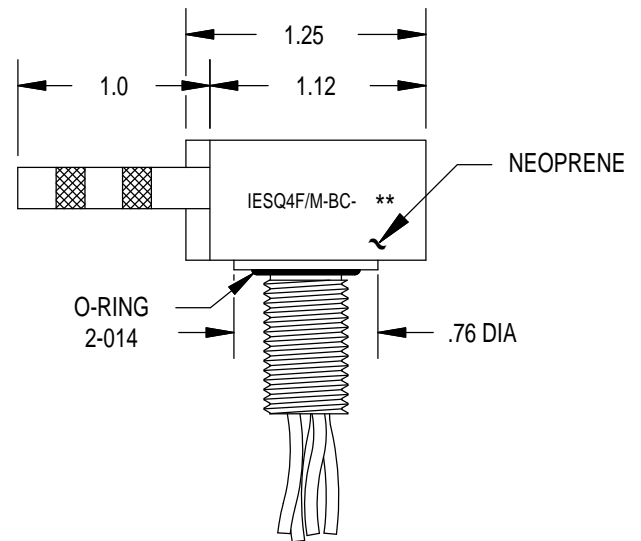
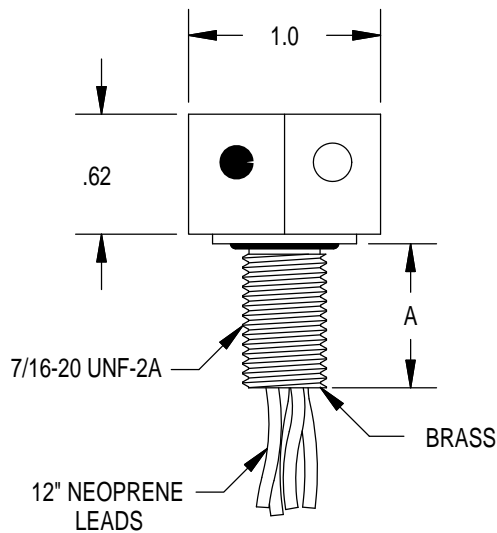
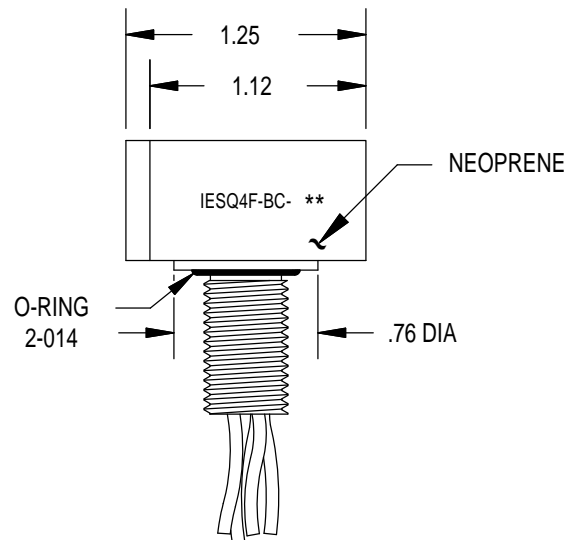
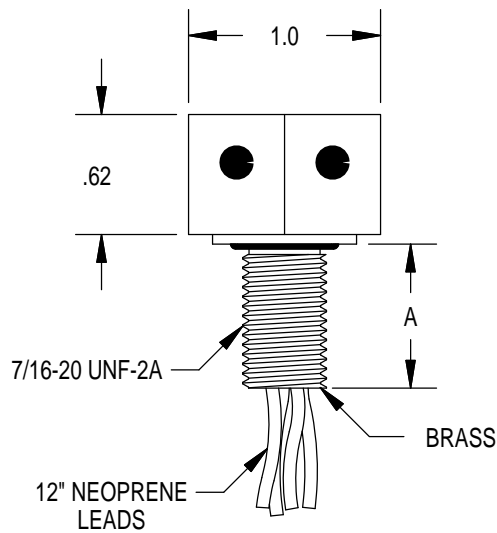
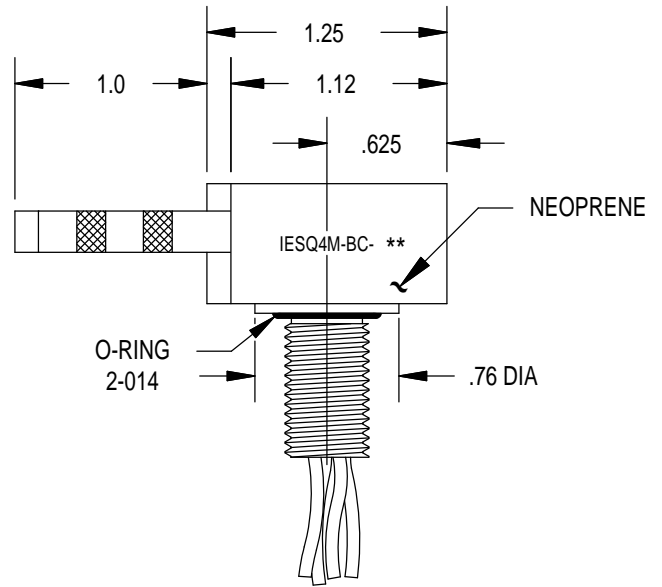
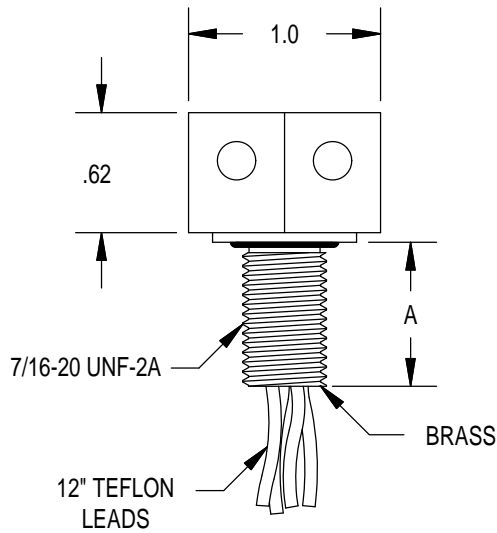

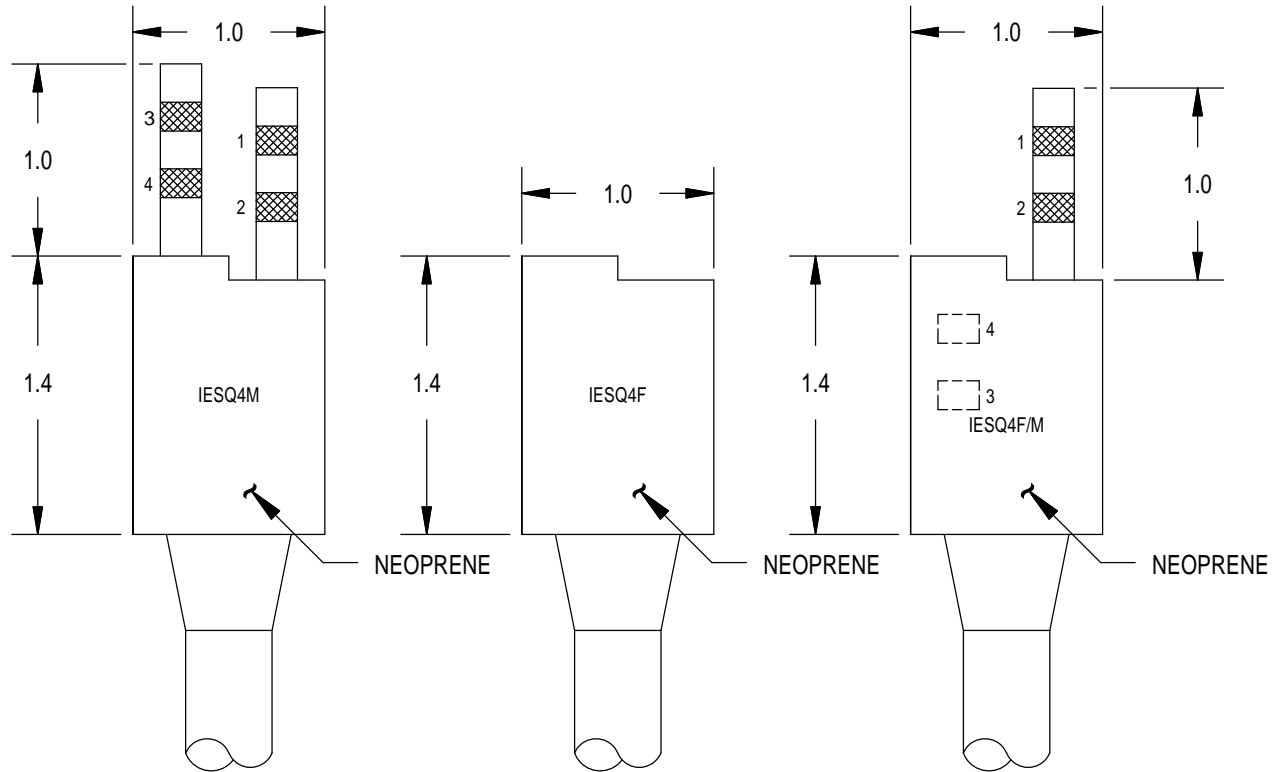

MOUNTING TORQUE FOR BC	not to exceed 100 in lbs
MATED PRESSURE RATING (psi)	5,000
DUMMY PLUG FOR IESQ4M-BC, IESQ4M	IESQ4F-DO *
DUMMY PLUG FOR IESQ4F-BC, IE2F	IESQ4M-DO *
DUMMY PLUG FOR IESQ4MF-BC, IESQ4F/M	IESQ4F/M-DO *
<p>* Dummy plugs found on Page 75 62. ** Shorted dummies available upon request. *** See chart for thread specifications. **** Specify M, F, F/M</p>	

BULKHEAD	
PART NUMBER	A
IESQ4****-BC-1	.50
IESQ4****-BC-2	.75
IESQ4****-BC-3	1.00

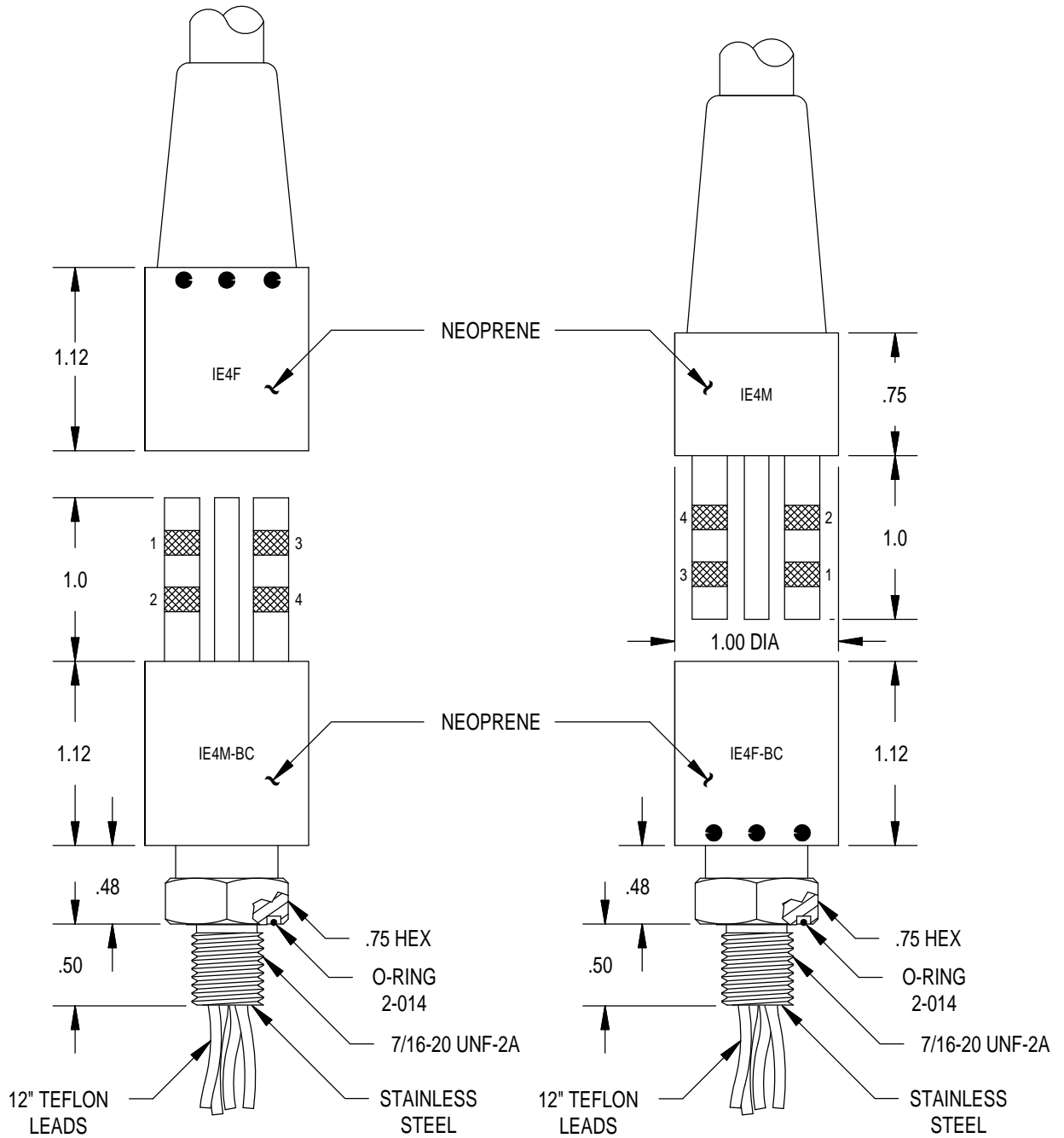

MOUNTING TORQUE FOR BC	not to exceed 100 in lbs
MATED PRESSURE RATING (psi)	10,000
DUMMY PLUG FOR IE4M-BC, IE4M	IE4F-DO *
DUMMY PLUG FOR IE4F-BC, IE4F	IE4M-DO *
* Dummied found on Page 75 63. ** Shorted dummies (DS) available upon request.	

CONTACT CONFIGURATION
(IE4M FACE VIEW)

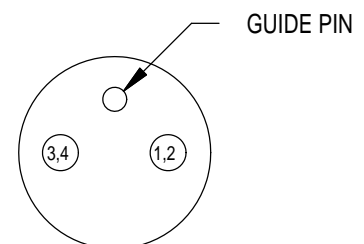

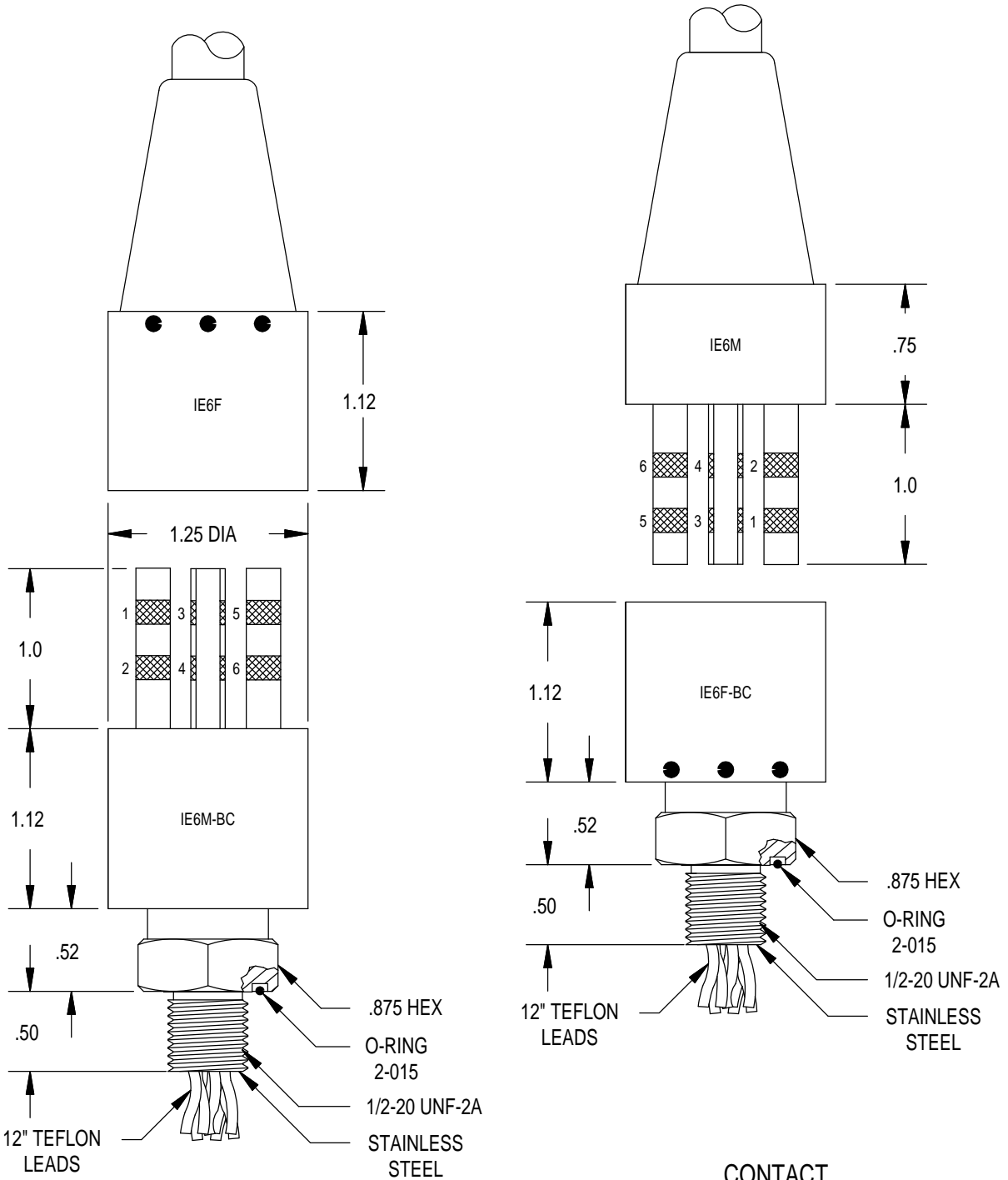

MOUNTING TORQUE FOR BC	not to exceed 100 in lbs
MATED PRESSURE RATING (psi)	10,000
DUMMY PLUG FOR IE6/8M-BC, IE6/8M	IE6/8F-DO *
DUMMY PLUG FOR IE6/8F-BC, IE6/8F	IE6/8M-DO *
* Dummy plugs found on Page 75 63. ** Shorted dummies (DS) available upon request.	

CONTACT CONFIGURATIONS
(IE6/8M FACE VIEWS)

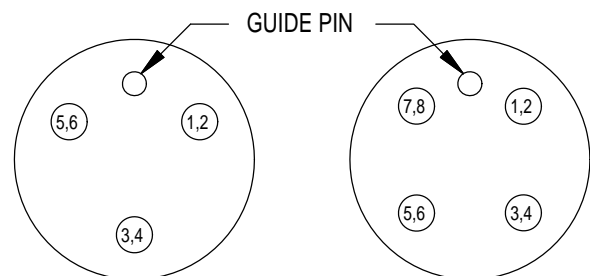

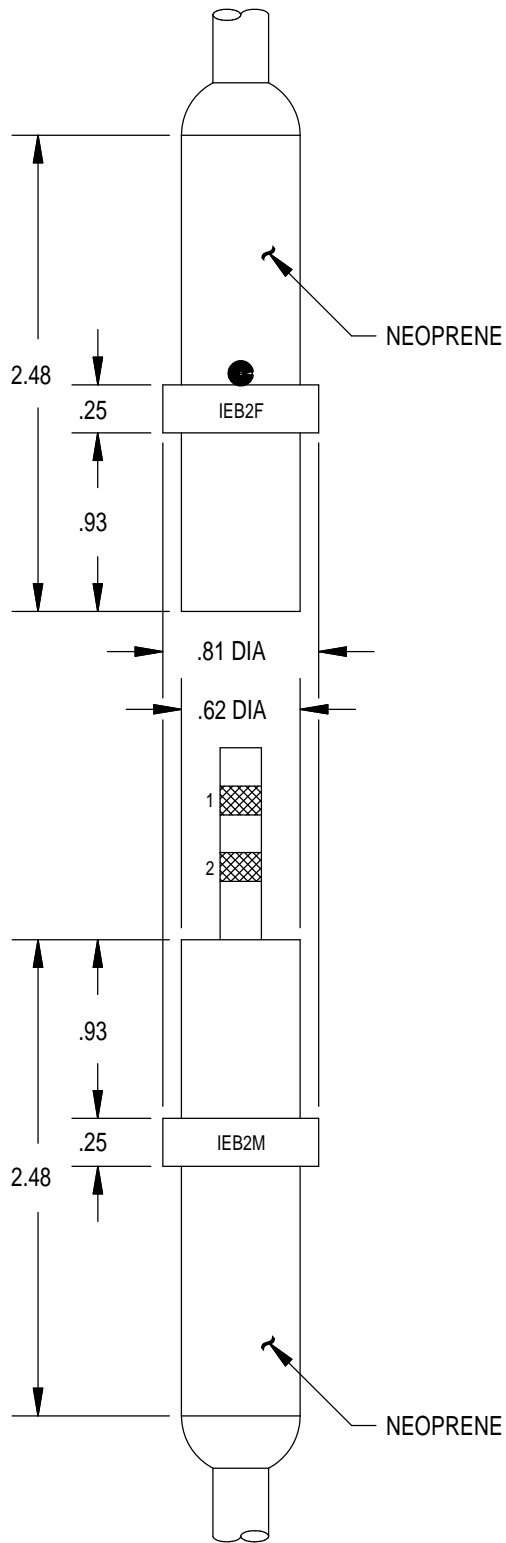

IEB2M FACE VIEW

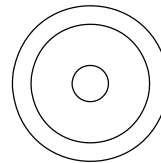

MATED PRESSURE RATING (psi)	10,000
DUMMY PLUG FOR IEB2M	IEB2F-DO *
DUMMY PLUG FOR IEB2F	IEB2M-DO *
* Dummy plugs found on Page 75 62. ** Shorted dummies (DS) available upon request.	

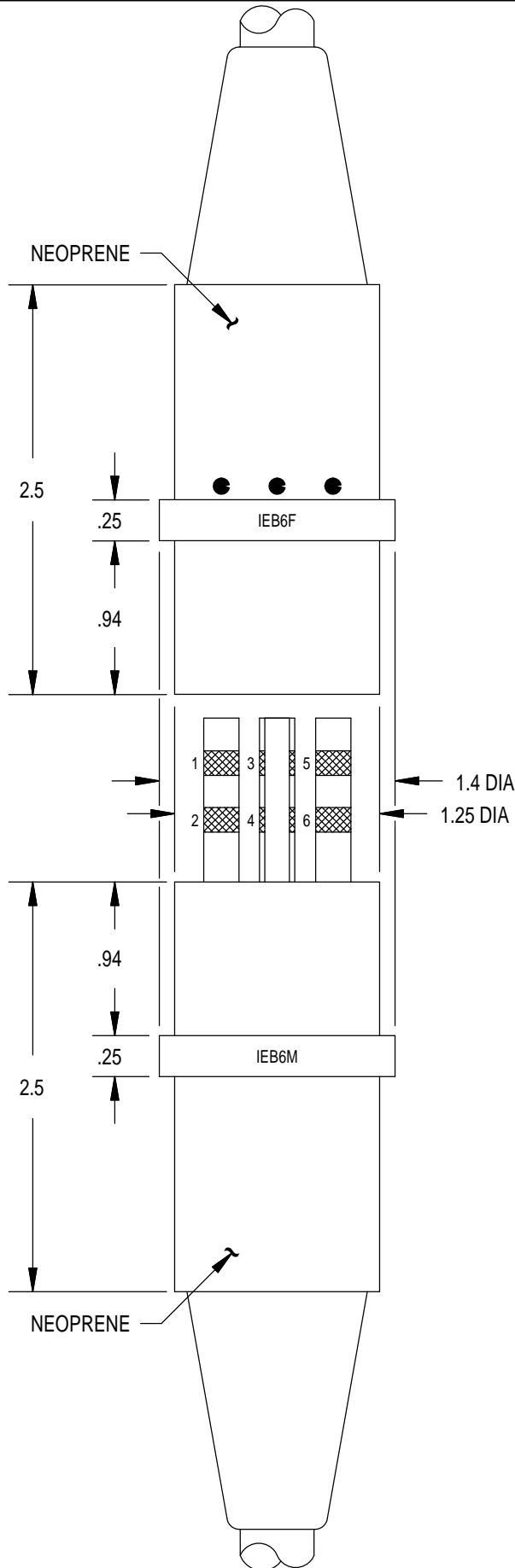

CONTACT CONFIGURATIONS
(IEB6/8M FACE VIEWS)

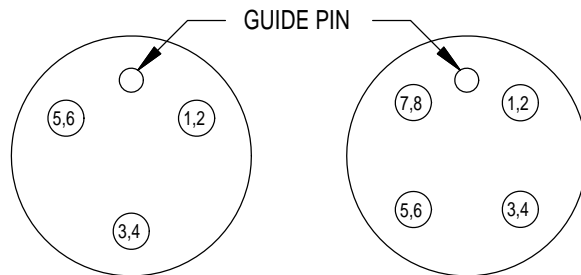

MATED PRESSURE RATING (psi)	10,000
DUMMY PLUG FOR IEB6/8M	IEB6/8F-DO *
DUMMY PLUG FOR IEB6/8F	IEB6/8M-DO *
<p>* Dummy plugs found on Page 75 63. ** Shorted dummies (DS) available upon request. *** Locking Sleeves found on Page 75 61.</p>	

DELTRIN LOCKING SLEEVES

MALE

6/8 CONTACT

FEMALE

IEB-6/8-MLS

IEB-6/8-FLS

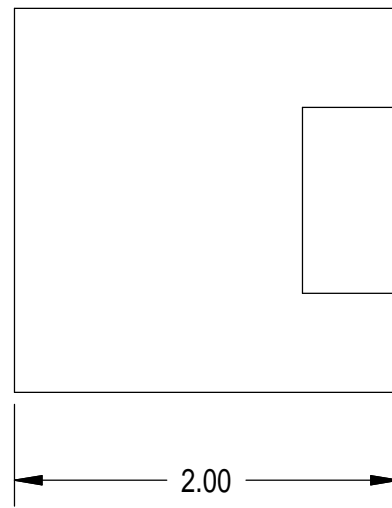
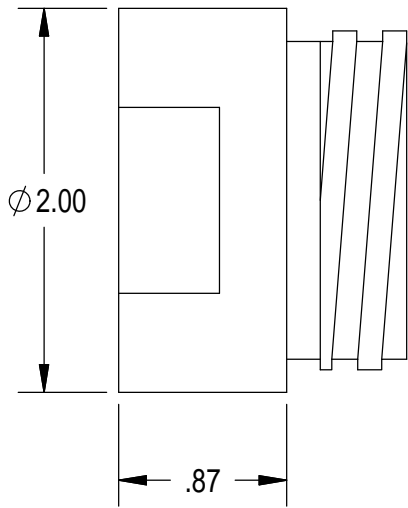

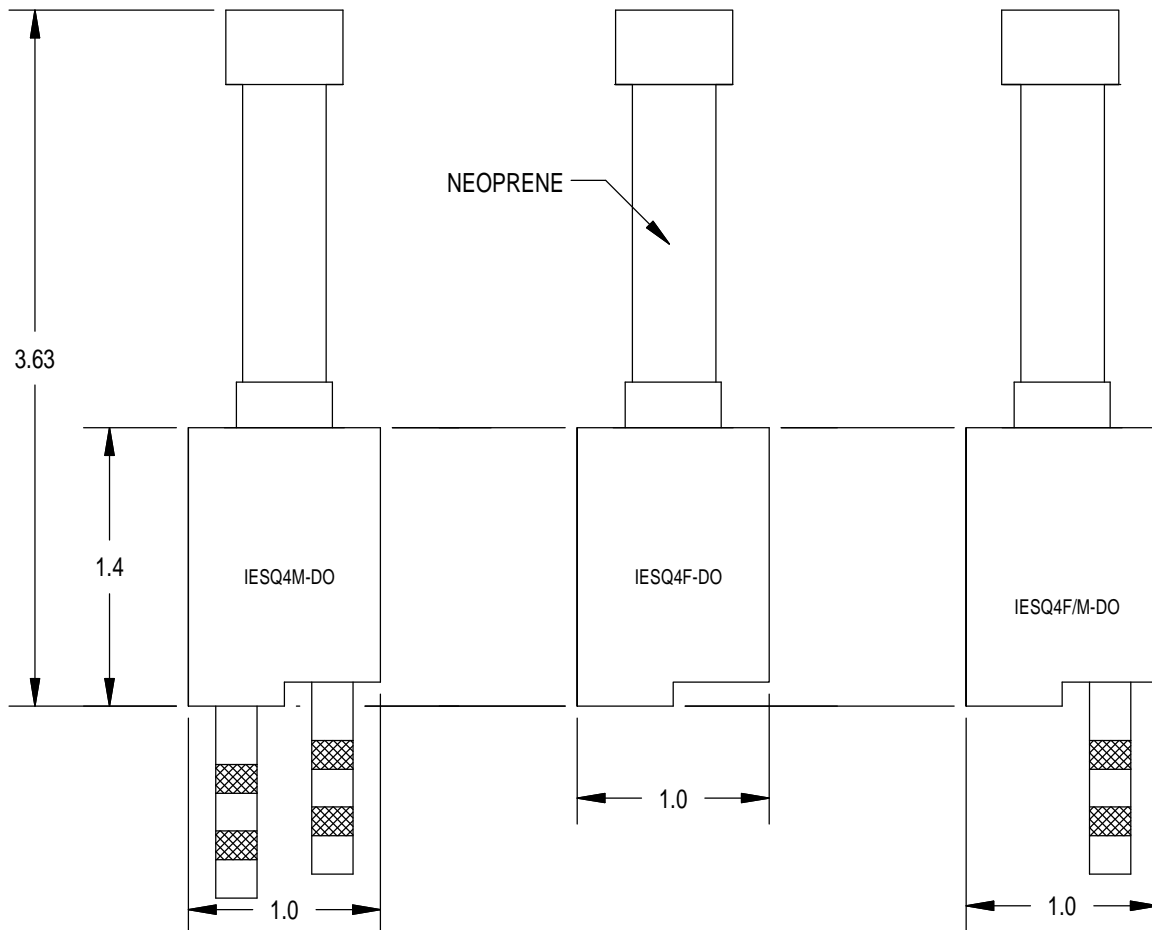
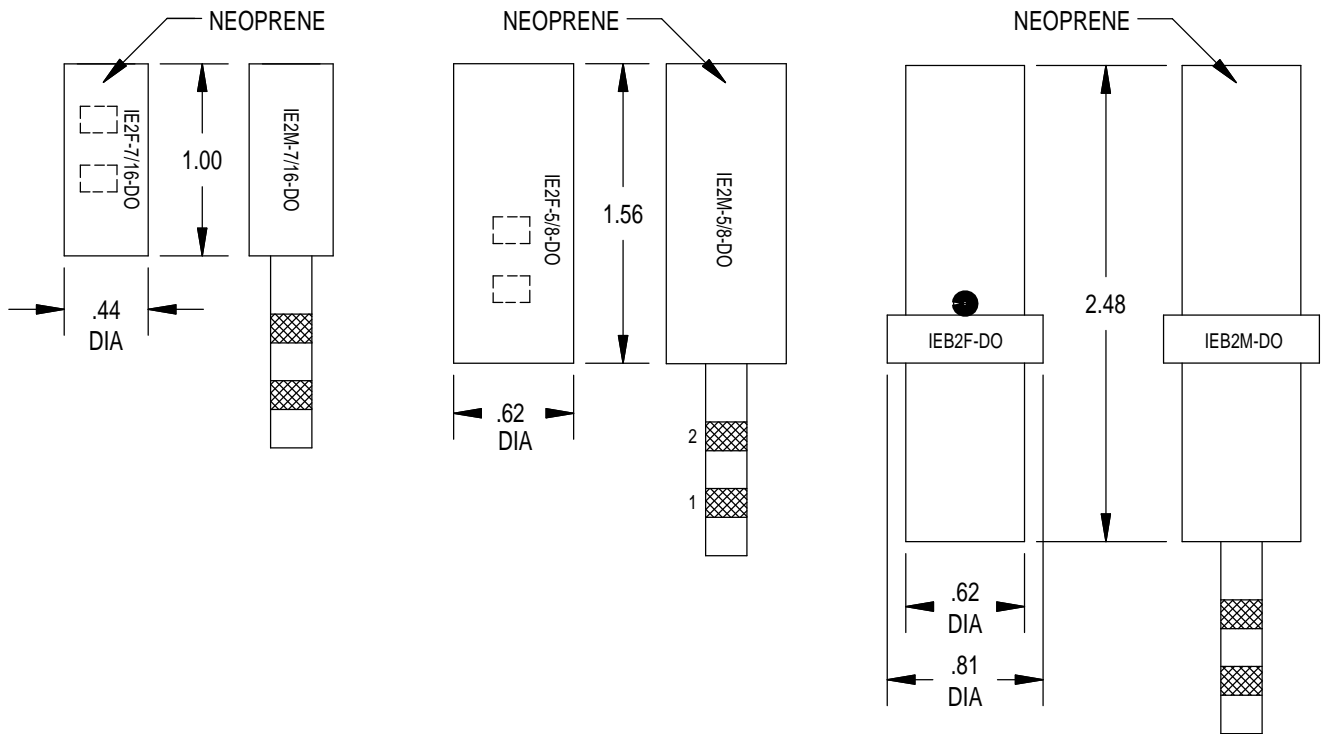

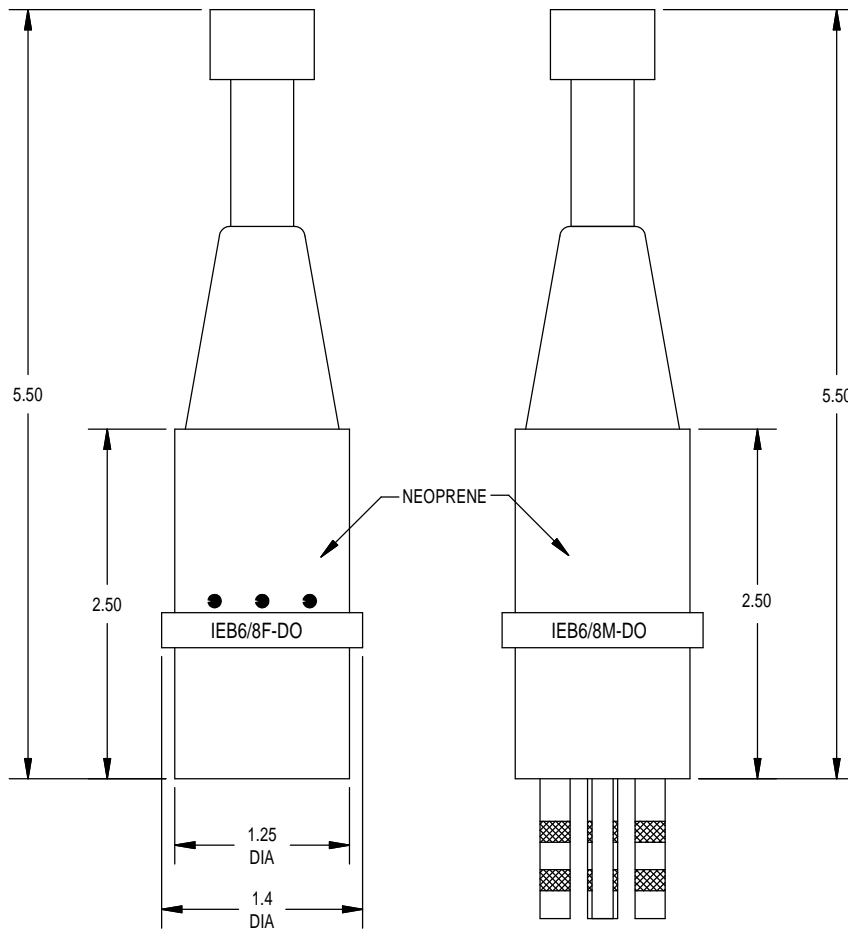
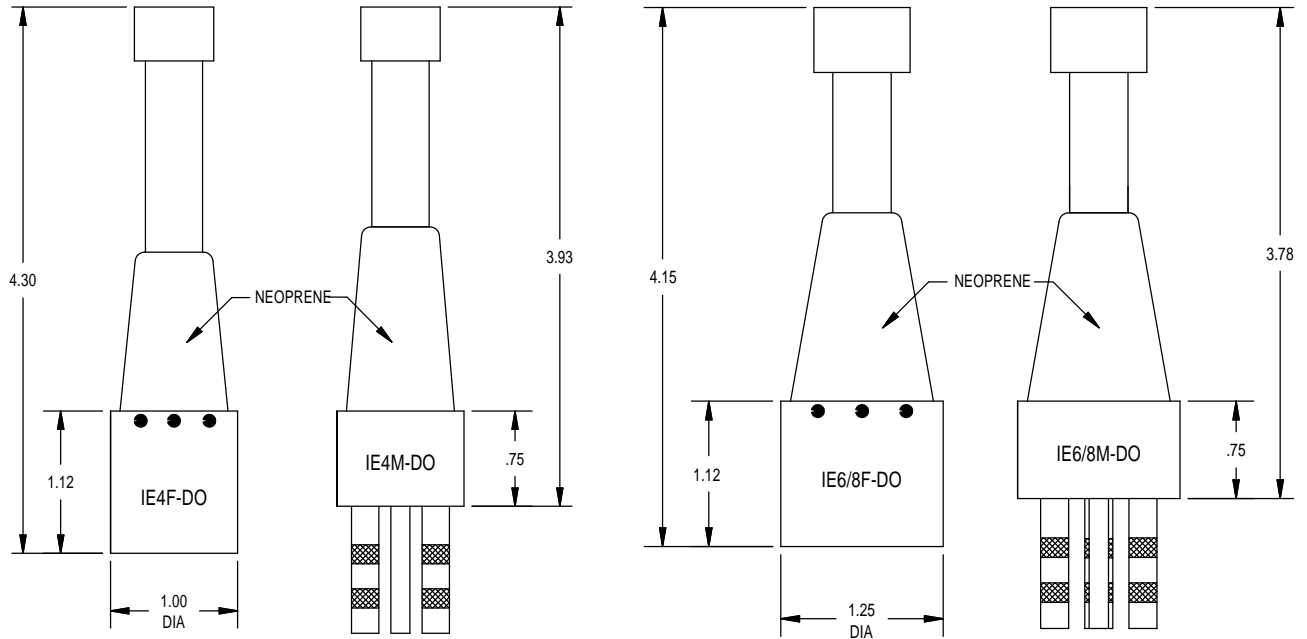

DESCRIPTION AND MATERIAL	<ul style="list-style-type: none">• Molded neoprene with improved sealing ability.• One to four contacts.• Up to 600 VDC, 10 AMPS.• Rated to 10,000 psi, contact factory for higher rating.• Bulkhead connector design open face pressure rated to 5000 PSI.• O-rings molded in female connector.
CABLE	<ul style="list-style-type: none">• Connectors in this series are molded on a 24" length of 16 AWG SO cable unless otherwise specified.• Bulkhead connectors have 12" teflon leads, Type E per MIL 16878/4 16 AWG, or 12" Belden 34416 leads (Neoprene jacket).
USES	<ul style="list-style-type: none">• Mates with other manufacturers connectors of same design.• Permits underwater plugging and unplugging with power off.• Light to heavy duty applications.• Hazardous environments.
GUIDELINES	<ul style="list-style-type: none">• All mounting surfaces require a 32 finish.• Lubricate male pins liberally with Dow Corning #111 Valve Lubricant or equivalent and apply a small amount in each hole of female socket. Connectors must be lubricated on a regular basis.• Lubricate o-rings with Dow Corning #111 Valve Lubricant or equivalent.• Replace o-rings when re-using connectors.• Align index pin prior to mating.• Avoid nicks and cuts around contacts as these are the sealing surfaces.• Elastomers can be seriously degraded if exposed to direct sunlight or high ozone levels for extended periods of time.• Do not over tighten bulkhead nuts.• Do not pull on cable to disconnect.• Avoid sharp bends at cable entry to connector.

IE31-BC

IE UNDERWATER PLUGGABLE SERIES 3

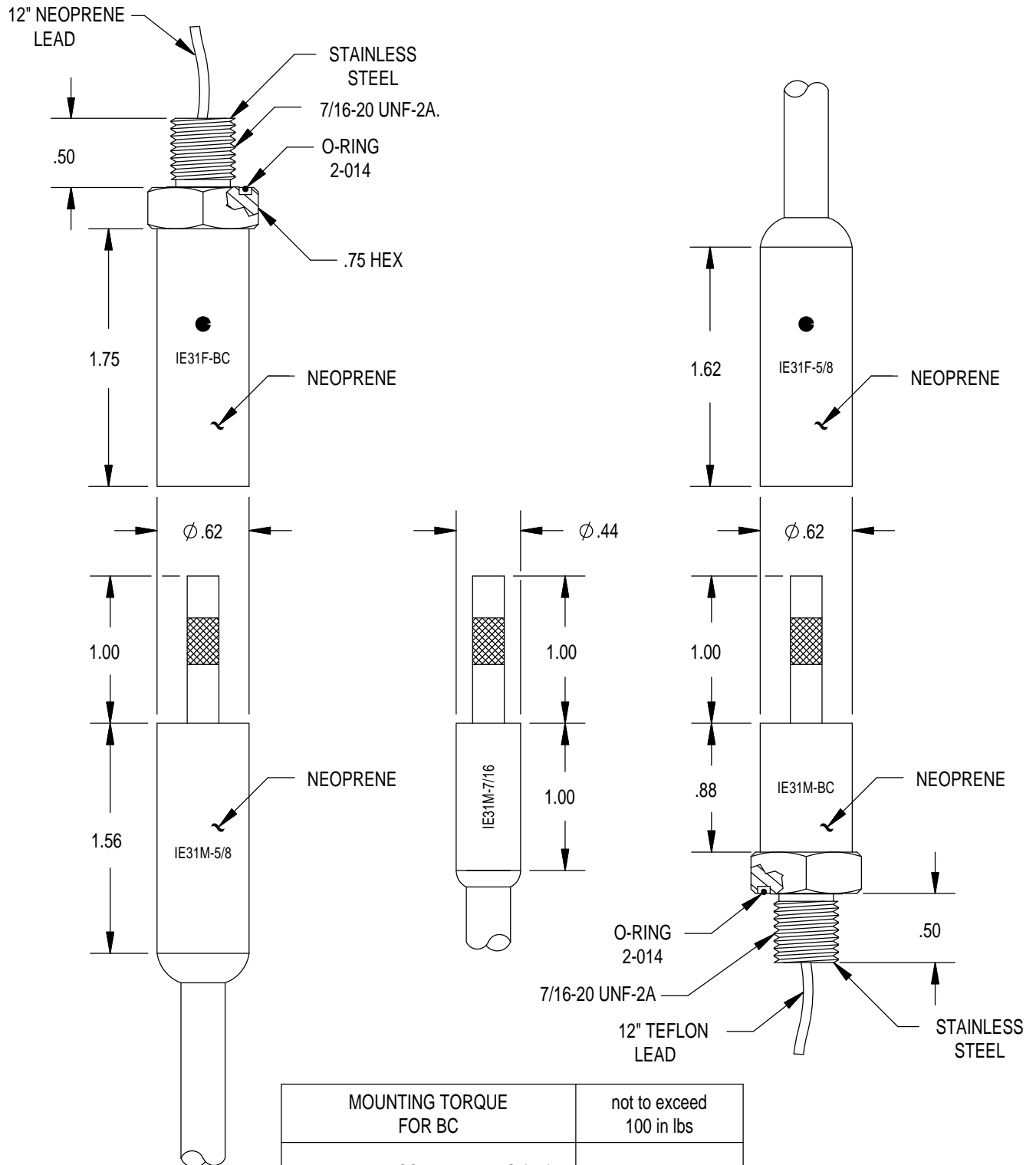

MOUNTING TORQUE FOR BC	not to exceed 100 in lbs
MATED PRESSURE RATING (psi)	10,000
DUMMY PLUG FOR IE31M-5/8, IE31M-BC	IE31F-5/8-DO *
DUMMY PLUG FOR IE31F-BC, IE31F-5/8	IE31M-5/8-DO *
* Dummy plugs found on Page 75 110	
** Shorted dummies (DS) available upon request	

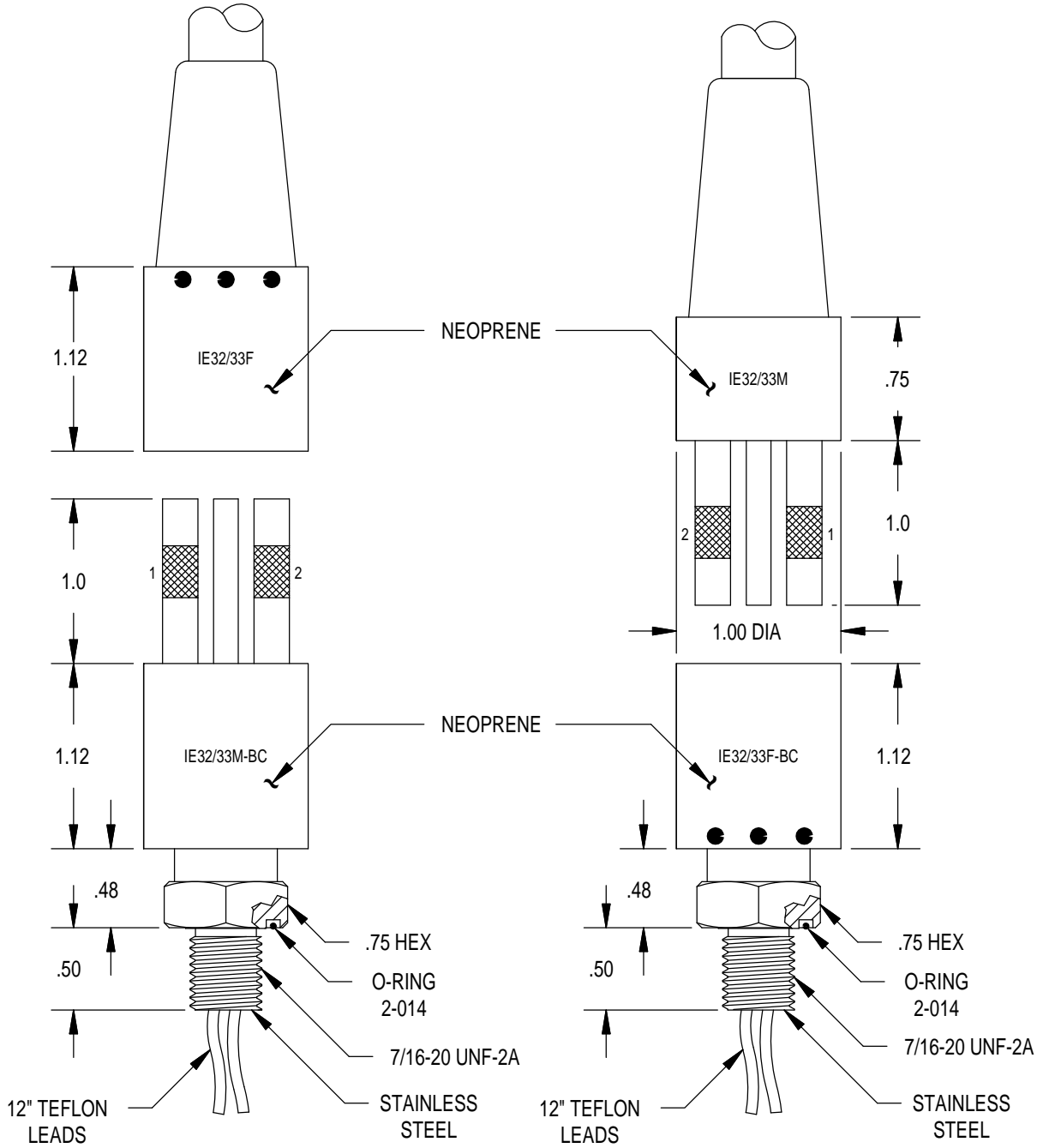

**CONTACT
CONFIGURATION**
(BC FACE VIEWS)

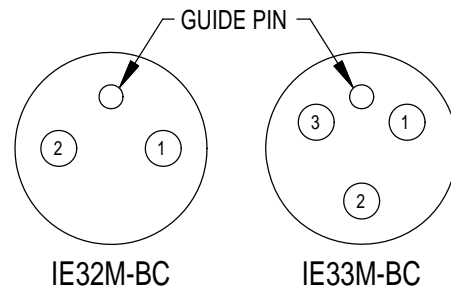

MOUNTING TORQUE FOR BC	not to exceed 100 in lbs
MATED PRESSURE RATING (psi)	10,000
DUMMY PLUG FOR IE32/33M-BC, IE32/33M	IE32/33F-DO *
DUMMY PLUG FOR IE32/33F-BC, IE32/33F	IE32/33M-DO *
* Dummy plugs found on Page 75 110. ** Shorted dummies (DS) available upon request	

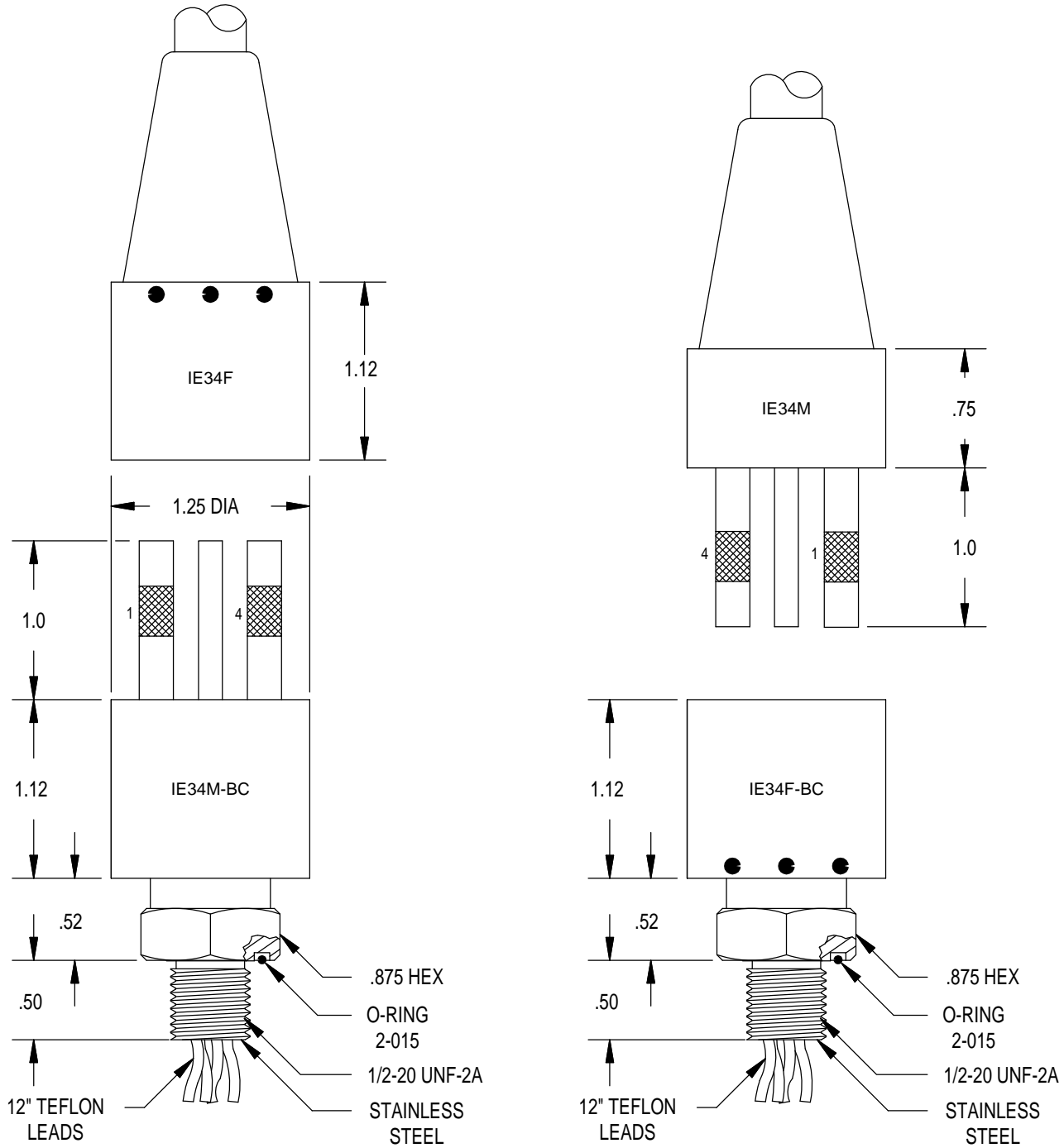

MOUNTING TORQUE FOR BC	not to exceed 100 in lbs
MATED PRESSURE RATING (psi)	10,000
DUMMY PLUG FOR IE34M-BC, IE34M	IE34F-DO *
DUMMY PLUG FOR IE34F-BC, IE34F	IE34M-DO *
* Dummy plugs found on Page 75 111. ** Shorted dummies (DS) available upon request.	

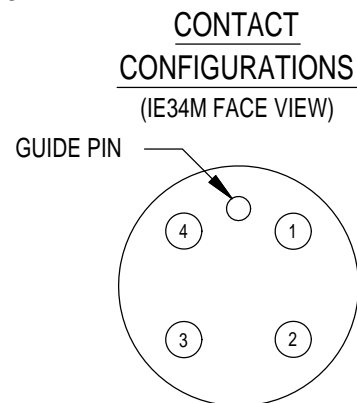

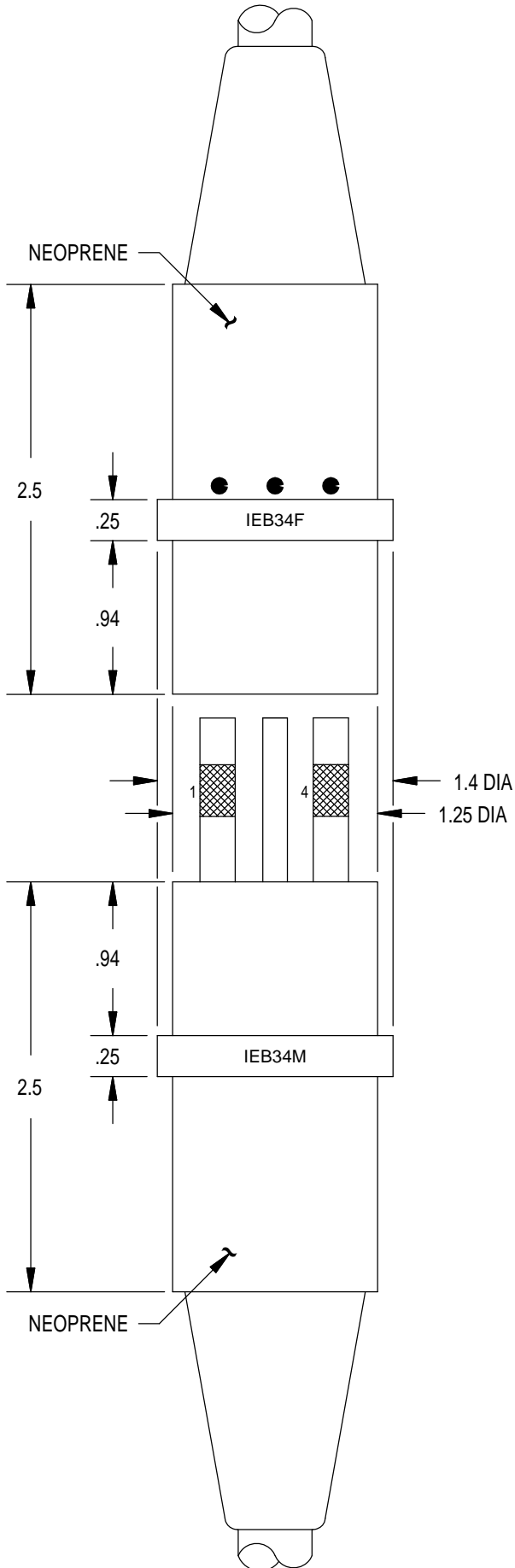

CONTACT
CONFIGURATIONS
(IEB34M FACE VIEW)

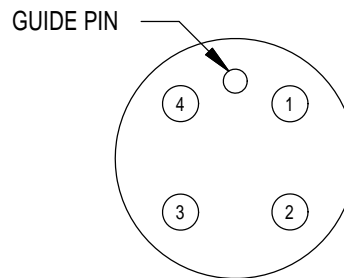

MATED PRESSURE RATING (psi)	20,000
DUMMY PLUG FOR IEB34M	IEB34F-DO *
DUMMY PLUG FOR IEB34F	IEB34M-DO *
* Dummy plugs found on Page 75 111. ** Shorted dummies (DS) available upon request.	

IESQ32-BC

IE UNDERWATER
PLUGGABLE SERIES 3

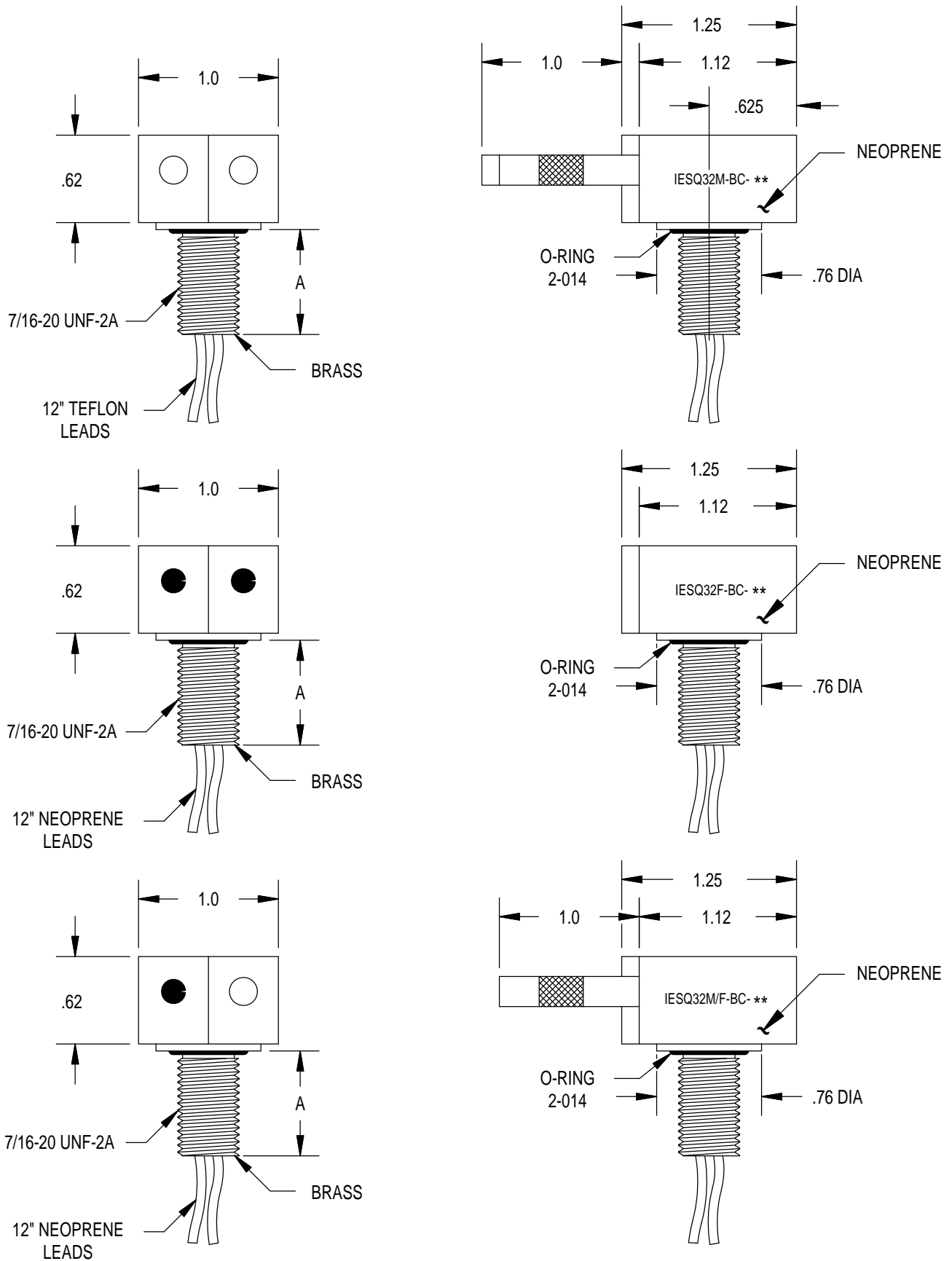

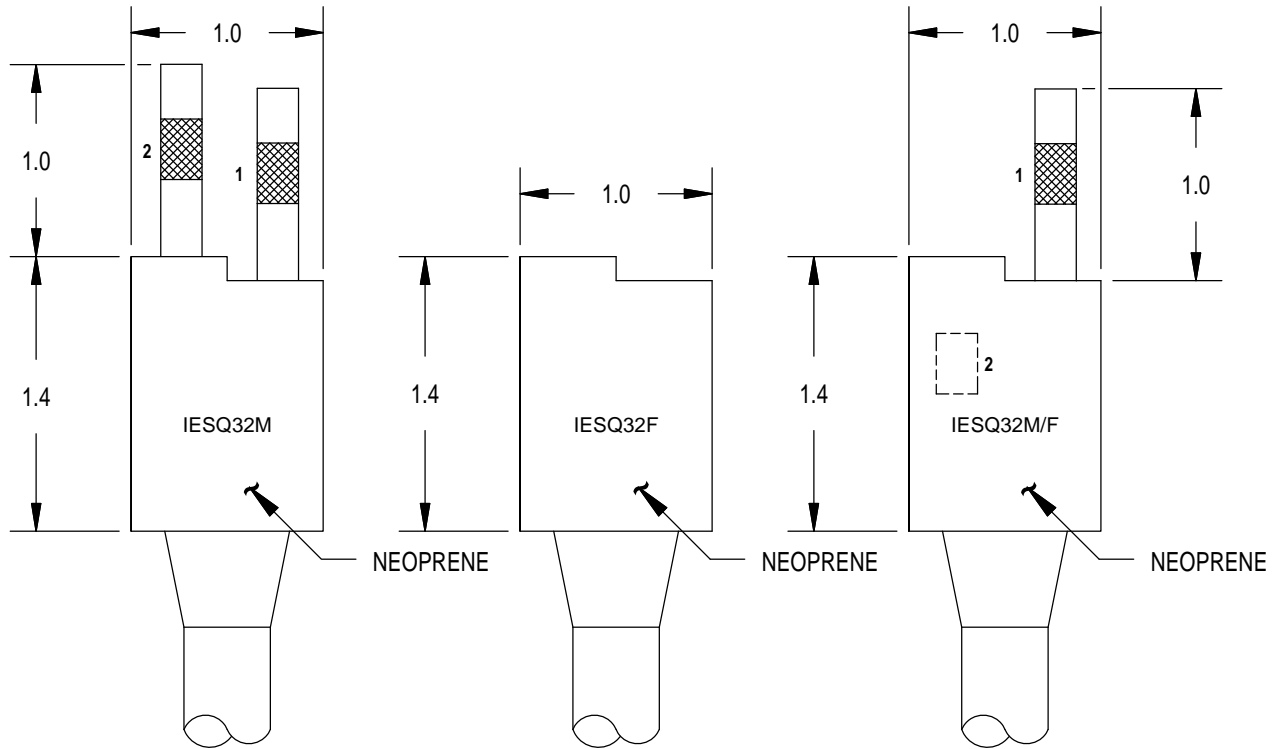

MOUNTING TORQUE FOR BC	not to exceed 100 in lbs
MATED PRESSURE RATING (psi)	5,000
DUMMY PLUG FOR IESQ32M-BC, IESQ32M	IESQ32F-DO *
DUMMY PLUG FOR IESQ32F-BC, IESQ32F	IESQ32M-DO *
DUMMY PLUG FOR IESQ32M/F-BC, IESQ32M/F	IESQ32M/F-DO *
<p>* Dummy plugs found on Page 75 112. ** Shorted dummies available upon request. *** See chart for thread specifications. **** Specify M/F/MF</p>	

BULKHEAD	
PART NUMBER	A
IESQ32 **** -BC-1	.50
IESQ32 **** -BC-2	.75
IESQ32 **** -BC-3	1.00

